

JMR-9200/7200 series Marine Radar

JRC

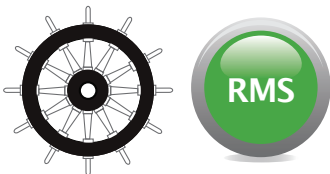

* The photograph includes options.

- Provide high performance with high functions in a more user-friendly manner.

- **Conforming to the latest IMO performance standards with Marine Equipment Directive (MED) certification.**
- **Ensuring intuitive and easy-to-use display and operation performance reflecting professional user's voices.**
- **A collision risk area display function "Safety Zone Viewer".**
- **Incorporating JRC original high-speed processor for great improvements in target detection performance.**
- **Delivered with a software license allowing an expansion tailored to each operational requirement for a wide variety of optional functions.**

JRC *Japan Radio Co., Ltd.*

JMR-9200/7200 series

Features

The JMR-9200/7200 series is a MED-certified marine radar incorporating a 26-inch-wide, 19-inch LCD and meeting the latest IMO performance standards. Incorporating a new Icon-based user interface to provide the latest functions in a user-friendly manner.



Sophisticated user interface

The JMR-9200/7200 series incorporates a new user interface (named jGUI) for an intuitive, easy-to-use, simple menu system based on the display of icons. This interface always displays critical data in fixed positions on the screen while icon-based menu display informs users of corresponding functions straightaway. Furthermore, target tracking (TT) and AIS symbols feature a pop-up displays while mouseover on the target showing their main data at a glance.

Easy-to-use operating unit

The newly designed trackball supports all the operation of the equipment. Users will be alerted with alarms from the operating unit and color changes under situations that require attention. The radar incorporates dedicated function buttons and control knobs similar to those of conventional models. Furthermore, the radar will be operable like conventional models by connecting an optional operating unit that incorporates a full keyboard.



Safety Zone Viewer function

By displaying areas of high collision risk on the radar screen, navigators can intuitively grasp safe navigation areas. It is also effective in planning a course of avoidance in congested waters, as the safe course can be seen at a glance.

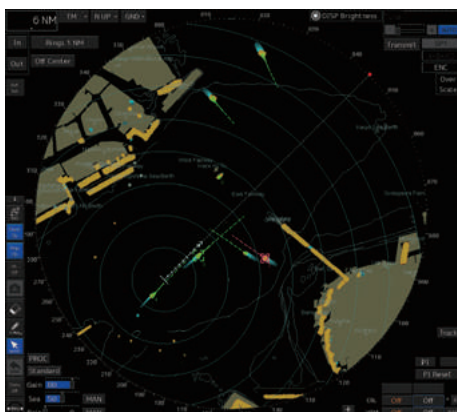
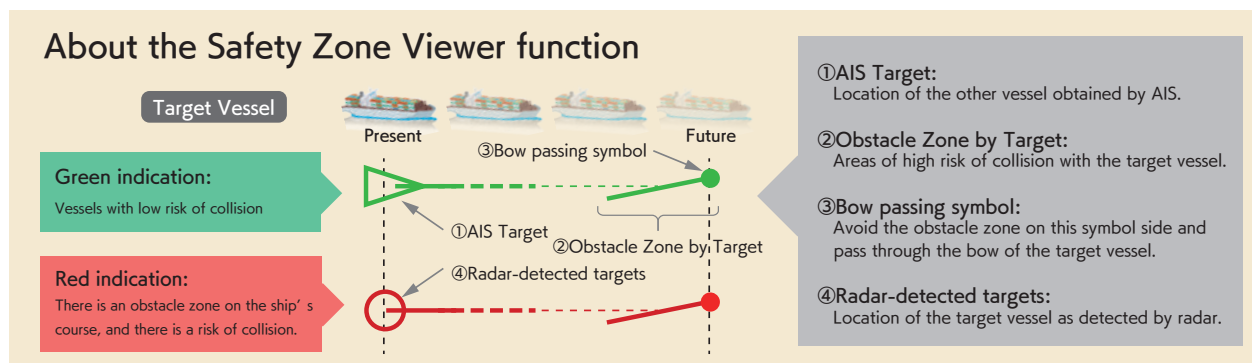

Safety Zone Viewer function Off

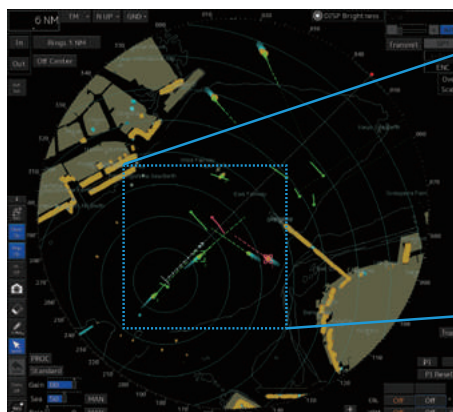

Safety Zone Viewer function On

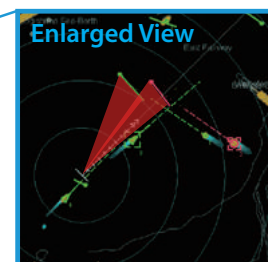

Red areas are collision hazard areas where the risk of collision is high if you take the right of way

Red areas are not displayed on the actual screen

JMR-9200/7200 series

Radar functions

JRC's new processor brings advanced usability

The JMR-9200/7200 series incorporates JRC's newly developed high-speed processor. The outstanding processing capability has achieved optimum signal processing according to the distance from the own ship. This has greatly improved the target detection performance of the radar in short-distant sea clutter (reflection from the waves). With the target tracking (TT) function of the radar operated in the background continuously, the movement vector of a target object and numerical information on the object can be displayed immediately after the user acquires the target. Furthermore, the JMR-9200 series with a 26-inch-wide screen makes it possible to use a second plan position indicator (PPI) in addition to the main PPI. While displaying two PPI's, it is possible to differentiate in range and off-center settings enabling the second PPI to expand a partial image around the own ship displayed in the main PPI and simultaneously monitor an area outside displayed on the main PPI.

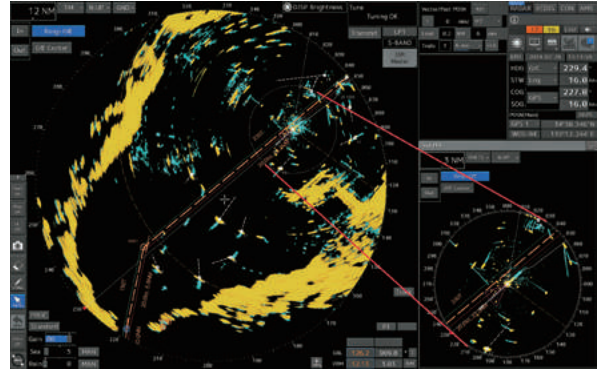

Unique radar functions inherited

The JMR-9200/7200 series incorporates the unique features of JRC's radars that have been receiving a favorable reputation over the last decade.

Constaview (Real-time head-up function)

The patented Constaview is realized through the use of two in-house built high-speed processors. All information gathered by the radar is fully processed within a few milliseconds before being displayed, generating a smooth image rotation. Even changing azimuth mode, the radar image is displayed without any delay caused by the scanner rotation.

Constaview

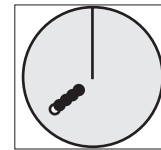

True Trails

Constaview refreshes the image every 16mS. Despite heading changes trails are always true.

Conventional

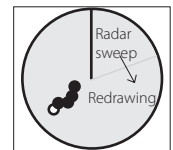

Relative Trails

Traditional technology relies on several sweeps of the scanner to redraw the image. Trails are presented as relative.

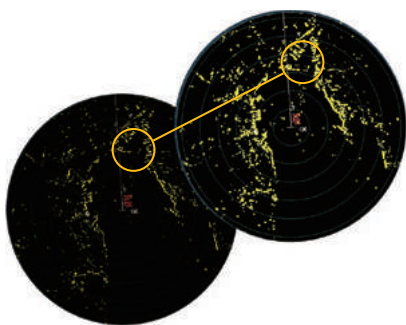

TEF (Target enhancement function)

Developed exclusively by JRC, TEF allows target enhancement relative to the target size. TEF works by adding pixels to targets displayed on the radar image and allows a vastly improved degree of discrimination between targets. Sophisticated processing results in a proportional enhancement where the relative enhancement of smaller targets is greater than applied to larger targets.

Solid-state scanner antenna

The JMR-9200/7200 series have been prepared X-band and S-band solid-state scanners. Each model incorporates a built-in performance monitor and has MED certification. A solid-state scanner antenna has the following advantages.

No preheating or tuning required

No preheating or tuning is required. A stable image will be obtained promptly after the power is turned on.

A built-in Doppler filter clearly extracts target objects

Conventional magnetron radars have difficulty in using Doppler filters. A new digital signal processing method has made improvements in target detection performance in clutters.

Magnetron replacement unnecessary

The product adopted a highly reliable solid-state transmission circuit, thus eliminating periodical magnetron replacement and leading to a maintenance cost reduction.

JMR-9200/7200 series

Functional expansion and configuration

Functional expansion

The equipment incorporates a variety of optional functions that will be available with software licenses added. Software licenses can be added before or after the radar comes into operation. Therefore, the radar can be customized to match the actual operating conditions.

Optional functions

- Chart radar function*1
- Safety Zone Viewer function*2
- Wave analysis function
- Expansion of AIS display targets (500 → 1000)

*1. The chart radar function requires ENC cell permits as well as ECDIS.

*2. Supported by software after by June 2022.



*The photograph includes options.

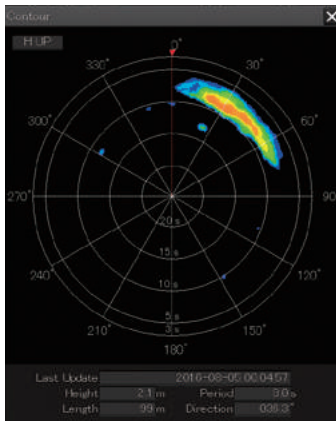

Wave analysis supports safe and fuel-efficient voyages

Sea surface reflection signals obtained around the own ship by the X-band radar are analyzed to display wave height, wave direction, wavelength, and wave cycle information along with spectrum images*3. The ship can take a course on the basis of information obtained from the wave analysis and suppress the pitching and rolling of the ship caused by waves, thus making it possible to ensure the safety of the crew members and cargo while saving the fuel consumption.

*3. The spectrum image is available to JMR-9200 series only.

VHF remote operation by radar

The radar offers a VHF remote operation function*4. This can be used to configure channels on the VHF unit or to perform DSC calls using AIS targets on the radar PPI screen. Features such as the wireless speaker mic*5 make it possible to communicate with other ships even when away from the VHF equipment.

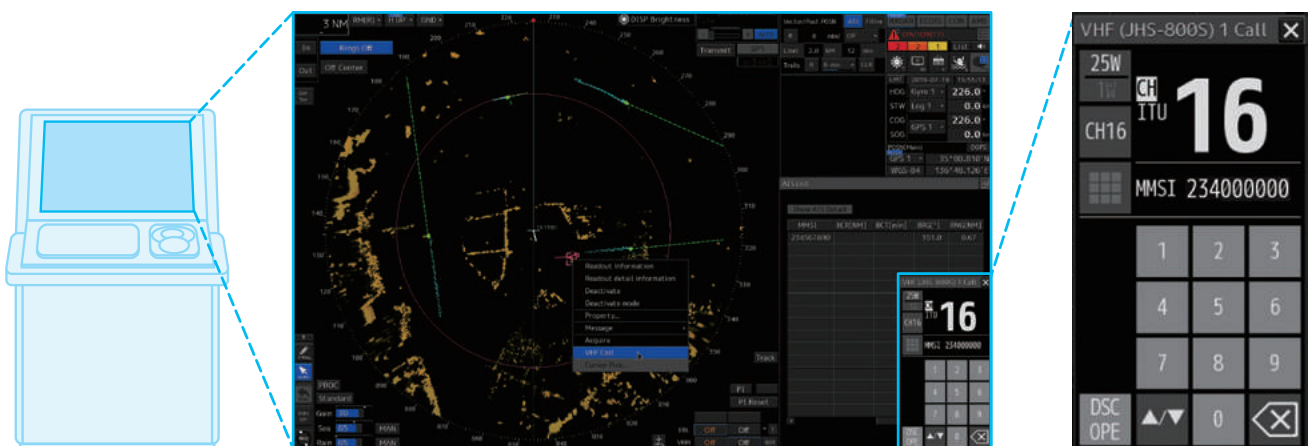

Example of radar JMR-9200 series 26-inch display

VHF screen

*4. The VHF supports the JHS-800S.

*5. Wireless speaker mic is option for the JHS-800S.

JMR-9200/7200 series

Functional expansion and configuration

Satellite transmission blocking area display^{*6}

During communications between JRC INMARSAT FBB or INMARSAT GX^{*7} equipment and satellites, the JMR-9200/7200 series equipment can display satellite antenna reception levels, blocking conditions, and transmission suspension^{*8}.

*6. Satellite transmission blocking area display is option, contact your JRC representative.

*7. The INMARSAT FBB and INMARSAT GX support the JUE-251/501 and the JUE-60GX.

*8. Transmission suspension supports only the JUE-60GX.



Sensor data sharing

The Central Control Unit is provided with the minimum required external interfaces specified by Marine Equipment Directives (MEDs), and other sensor data is received through the bridge network (LAN) from the interface circuits. The interface circuits are designed to be shared by a number of new-type navigation devices, and each type of interface circuit can be combined and selected according to each signal format and the number of connections.



Interface circuit arrangement in NQE-1143 Junction Box

SLC	AOC	GIF	RIF
			✓
✓			✓
		✓	✓
✓	✓		✓
✓		✓	✓
✓	✓	✓	✓

Interface circuits in combination (Please refer to Block diagram)

Block diagram

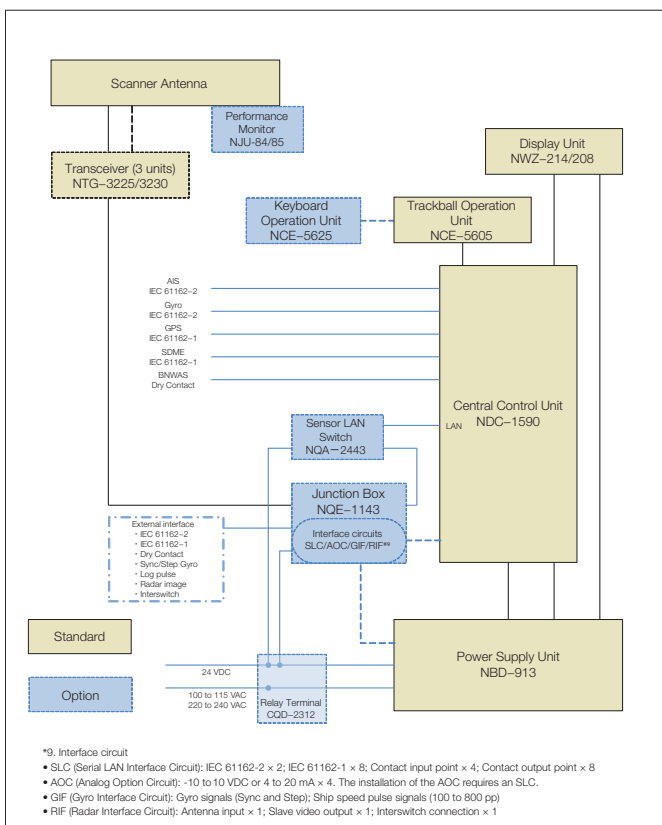

In the box

- Central Control Unit
- Power Supply Unit
- Display Unit
- Trackball Operation Unit
- Scanner Antenna
- Transceiver (in the case of 3 units antenna)

Options

- Keyboard Operation Unit
- Sensor LAN Switch
- Junction Box
- Serial LAN Interface Circuit
- Analog Option Circuit
- Gyro Interface Circuits
- Radar Interface Circuit
- Relay Terminal Block
- Display Unit Mount Kit
- Performance Monitor (applicable to some scanner antennas)
- Interswitch (4 ch/8 ch)

JMR-9200/7200 series

Dimensions and weight

19-inch Display and Desktop Frame

NWZ-214 Weight: 4.6 kg **CWB-1594^{*1}** Weight: 3.6 kg

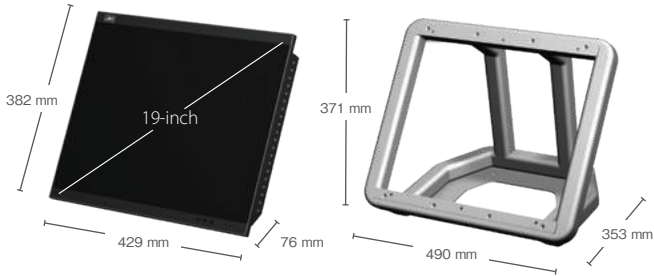

26-inch Display and Desktop Frame

NWZ-208 Weight: 16 kg **CWB-1595^{*1}** Weight: 5.5 kg

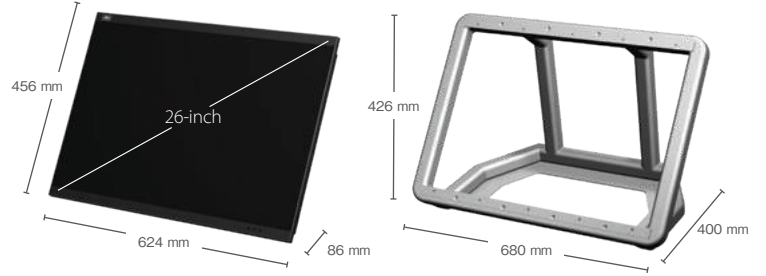

Central Control Unit

NDC-1590 Weight: 5.6 kg



Power Supply Unit

NBD-913 Weight: 4.2 kg



Trackball Operation Unit

NCE-5605 Weight: 1.3 kg



Keyboard Operation Unit

NCE-5625^{*1} Weight: 0.8 kg



Junction Box

NQE-1143^{*1} Weight: 3.8 kg

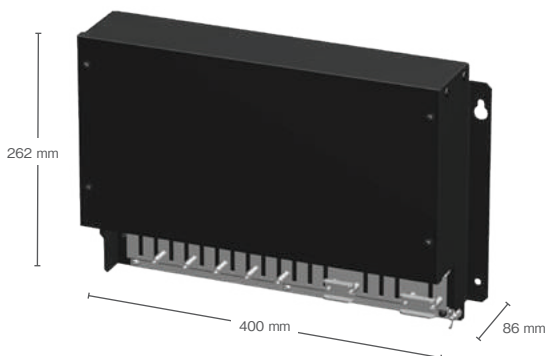

19-inch Cradle Frame and 26-inch Cradle Frame

CWA-245^{*1} Weight: 55 kg **CWB-246^{*1}** Weight: 65 kg

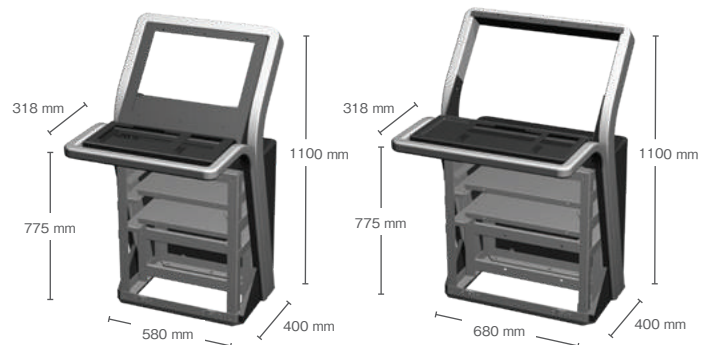

*1. Option. *2. The performance monitor is option. *3. The transceiver NTG-3225 is required.

10 kW 6 ft X-band Scanner Antenna (2 units)

NKE-2103-6¹² (27 rpm)/NKE-2103-6HS¹² (48 rpm) Weight: 40 kg
Swing circle: 1910 mm

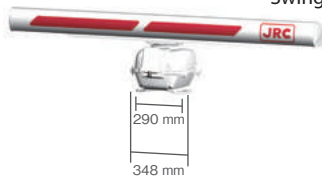

25 kW 6 ft X-band Scanner Antenna (2 units)

NKE-1125-6¹² (24 rpm)/NKE-2254-6HS¹² (48 rpm) Weight: 55 kg
Swing circle: 1910 mm

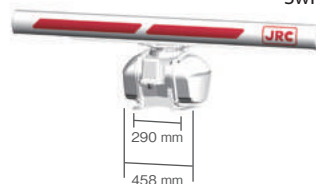

25 kW 9 ft X-band Scanner Antenna (2 units)

NKE-1125-9¹² (24 rpm) Weight: 60 kg
Swing circle: 2825 mm

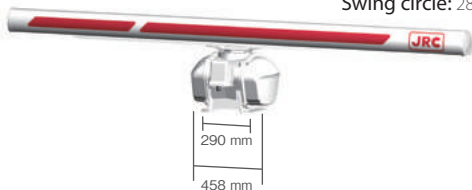

25 kW 7 ft X-band Scanner Antenna (3 units*³)

NKE-1129-7¹² (24 rpm) Weight: 51 kg
Swing circle: 2270 mm

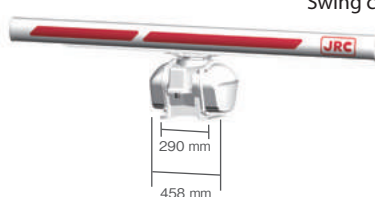

25 kW 9 ft X-band Scanner Antenna (3 units*³)

NKE-1129-9¹² (24 rpm) Weight: 53 kg
Swing circle: 2825 mm

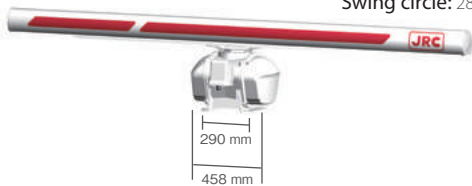

30 kW 12 ft S-band Scanner Antenna (2 units)

NKE-1130¹² (24 rpm) Weight: 180 kg
Swing circle: 4000 mm



30 kW 12 ft S-band Scanner Antenna (3 units*³)

NKE-1139¹² (24 rpm) Weight: 165 kg
Swing circle: 4000 mm



600 W 6 ft X-band Solid-state Scanner Antenna (2 units)

NKE-1696-6 (24 rpm) Weight: 53 kg
Swing circle: 1880 mm

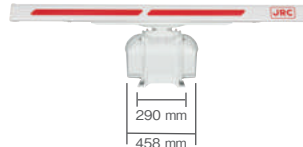

600 W 9 ft X-band Solid-state Scanner Antenna (2 units)

NKE-1696-9 (24 rpm) Weight: 58 kg
Swing circle: 2810 mm

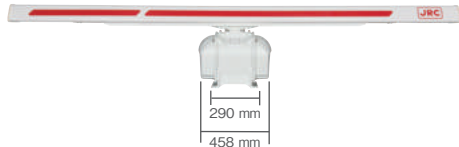

250 W 8 ft S-band Solid-state Scanner Antenna (2 units)

NKE-2632 (24 rpm) Weight: 85 kg
Swing circle: 2770 mm

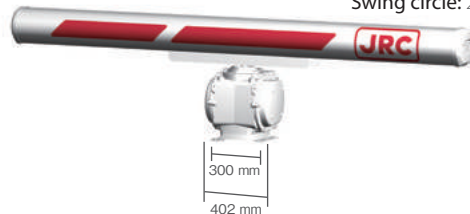

250 W 8 ft S-band Solid-state Scanner Antenna (2 units)

NKE-2632-H (48 rpm) Weight: 90 kg
Swing circle: 2270 mm

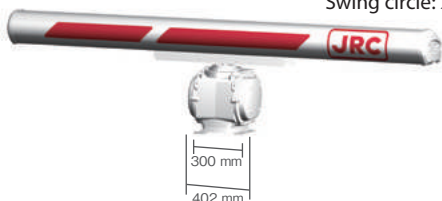

250 W 12 ft S-band Solid-state Scanner Antenna (2 units)

NKE-1632 (24 rpm) Weight: 160 kg
Swing circle: 4000 mm



JMR-9200/7200 series

Specifications

Model	26-inch type*1		JMR-9210-6X	JMR-9225-6X	JMR-9225-6XH	JMR-9225-7X3	JMR-9230-S	JMR-9230-S3	JMR-9282-S	JMR-9272-S	JMR-9296-6X	JMR-9296-9X	
	19-inch type*1		JMR-7210-6X	JMR-7225-6X	JMR-7225-6XH	JMR-7225-7X3	JMR-7230-S	JMR-7230-S3	JMR-7282-S	JMR-7272-S	JMR-7296-6X	JMR-7296-9X	
Conforming to IMO standards	✓		✓	✓	✓	✓	✓	✓	✓	✓	✓	✓	
Unit configuration			2 unit configuration			3 unit configuration ^{*2}	2 unit configuration	3 unit configuration ^{*3}	2 unit configuration		2 unit configuration		
Performance Monitor			NJU-85				NJU-84		Built-in		Built-in		
Frequency			X-band				S-band				X-band		
Display			Color raster scan PPI										
Scanners													
Model*1			NKE-2103-6	NKE-1125-6	NKE-2254-6HS	NKE-1129-7	NKE-1130	NKE-1139	NKE-2632	NKE-1632	NKE-1696-6	NKE-1696-9	
Antenna length			6 feet	6/9 feet	6 feet	7/9 feet	12 feet		8 feet	12 feet	6 feet	9 feet	
Transmission output			10 kW		25 kW		30 kW		250 W (solidification)		600 W (solidification)		
Transmission frequency			9410 MHz ± 30 MHz			3050 MHz ± 20 MHz			PON: 3035 MHz QON: 3065±4 MHz or 3060±4 MHz		PON: 9410 MHz QON: 9440±4 MHz or 9435±4 MHz		
Horizontal beam width			1.2°	6 feet: 1.2° 9 feet: 0.8°	1.2°	7 feet: 1.0° 9 feet: 0.8°	1.9°		2.7°	1.9°	1.2°	0.8°	
Vertical beam width			20°			25°			25°		20°		
Rotational speed			27 rpm 48 rpm(high-speed rotation)	24 rpm	48 rpm(high-speed rotation)	24 rpm	24 rpm		24 rpm 48 rpm(high-speed rotation)	24 rpm	24 rpm		
Pulse width/Frequency*4			0.08 μs/2250 Hz	0.07 μs/2250 Hz, 0.2 μs/2250 Hz						0.07 μs/(4.6 μs, 8 MHz)/1860 Hz or 2280 Hz		0.07 μs/(4.6 μs, 8 MHz)/1360 Hz or 1700 Hz	
			0.25 μs/1700 Hz	0.3 μs/1900 Hz, 0.4 μs/1400 Hz						0.14 μs/(9.1 μs, 8 MHz)/1860 Hz or 2280 Hz		0.14 μs/(4.6 μs, 8 MHz)/1360 Hz or 1700 Hz	
			0.5 μs/1200 Hz	0.8 μs/750 Hz						0.29 μs/(9.1 μs, 8 MHz)/1860 Hz or 2280 Hz		0.28 μs/(9.1 μs, 8 MHz)/1000 Hz	
			0.8 μs/750 Hz	1.0 μs/650 Hz						0.57 μs/(9.1 μs, 8 MHz)/1280 Hz		0.56 μs/(9.1 μs, 8 MHz)/1000 Hz	
1.0 μs/650 Hz			1.2 μs/510 Hz						1.14 μs/(18.3 μs, 8 MHz)/640 Hz		1.12 μs/(9.1 μs, 9 MHz)/660 Hz or 730 Hz		
Duplexer			Circulator + Diode limiter				Circulator + TRHPL		Circulator + Diode limiter		Circulator + Diode limiter		
Range scale			0.125, 0.25, 0.5, 0.75, 1.5, 3, 6, 12, 24, 48, 96 NM										
Motor			Brushless										
Tuning			Auto/Manual										
Ambient conditions			Temperature: -25 °C to +55 °C (NTG-3225/NTG-3230: -15 °C to +55 °C); Relative humidity: 93 % @40 °C										
Display Unit													
LCD			JMR-9200: 26-inch WUXGA color LCD, 1920 × 1200 dots JMR-7200: 19-inch SXGA color LCD, 1280 × 1024 dots										
PPI effective diameter			JMR-9200: 320 mm min. JMR-7200: 250 mm min.										
Azimuth display mode			North up, course up, and head up										
Operation mode			Relative motion - True trails; Relative motion - Relative rails; True movement - True rails										
EBL			Two (EBL1/EBL2), (Center/Independent), 000.0 to 359.9°, Four-digit display										
VRM			Two (VRM1/VRM2), 0.000 to 96.0 NM, Four-digit display										
Sea surface/Rain and snow reflection suppression			Auto/Manual										
Trail display			Short (off, 15 s to 60 mins.)/Long (off, 30 mins to 24 hrs.), Two modes										
Own ship trail records			24 hours										
User map			100,000 points										
Off-center			66 % of the radius (excluding 96 NM range)										
Number of TT tracking targets			100 max.										
TT tracking range			Auto/Manual 32 NM max.										
Number of AIS targets			500 targets max. (expanding to a maximum 1,000 targets with an optional function added)										
TT/AIS vector			True/Relative, variable from 1 to 120 minutes										
Ambient conditions			Operating temperature: -15 °C to +55 °C; Relative humidity: 93 % @40 °C										
Power supply voltage			100 to 115 VAC, 50/60 Hz, 1 φ/220 to 240 VAC, 50/60 Hz, 1 φ/24 VDC										
Option													
Chart radar function			Software license										
Expansion of number of AIS display targets			Software license										
Wave analysis function			Software license										
Keyboard Operation Unit			NQE-5625										
Junction Box			NQE-1143										
Interface Circuits			CMH-2370 (Serial LAN Interface Circuit) / CMJ-560 (Analog Option Circuit) / CMJ-554 (Gyro Interface Circuit)										
Self-stand Frame			CWA-245 (19-inch) / CWA-246 (26-inch)										
Power Control Unit			NQE-3167										
Interswitch			NQE-3141-4A (box, up to 4 units)										
Interswitch			NQE-3141-8A (box, up to 8 units)										
Anti-icing Antenna*5			None	NKE-1125-6D/9D	NKE-2254-6HSD	NKE-1129-7D/9D	NKE-1130D	NKE-1139D	NKE-2632D/E	NKE-1632D/E	NKE-1696D/E		

*1. Each model with the model number suffix "H" is a high-speed rotation model.

*2. External transceiver: NTG-3225

*3. External transceiver: NTG-3230

*4. The NKE-2632/1632/1696 scanner antennas: Transmission pulse width (1st)/(Transmission pulse width and frequency shift width (2nd))/Repetition frequency

*5. The supply voltage of each model is shown by the suffix. D: 100 VAC and E: 220 VAC

• Specifications may be subject to change without notice.

For further information, contact:



Since 1915

Japan Radio Co., Ltd.

URL <https://www.jrc.co.jp/eng/>

Tatsumi Office: 7-32, Tatsumi 1-chome, Koto-ku, Tokyo
135-0053, Japan
Telephone: +81-3-5534-1207
Facsimile: +81-3-5534-1199

Overseas Branches: Athens, Manila
Liaison Offices: Taipei, Hanoi, New York
Overseas Subsidiaries: Busan, Shanghai, Singapore
Jakarta, Rotterdam, Egersund
Houston, Rio de Janeiro

36EM

ISO9001, ISO14001 Certified

© 2017.1

2023.6

CAT.No.Y9-179 (No.715-4-0) Z